

REVISIONS			
REV.	DESCRIPTION	DATE	ECN

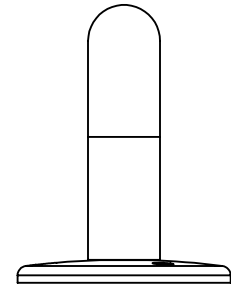

8-120 FLANGE
W/HDWR.
(2 PLCS.)

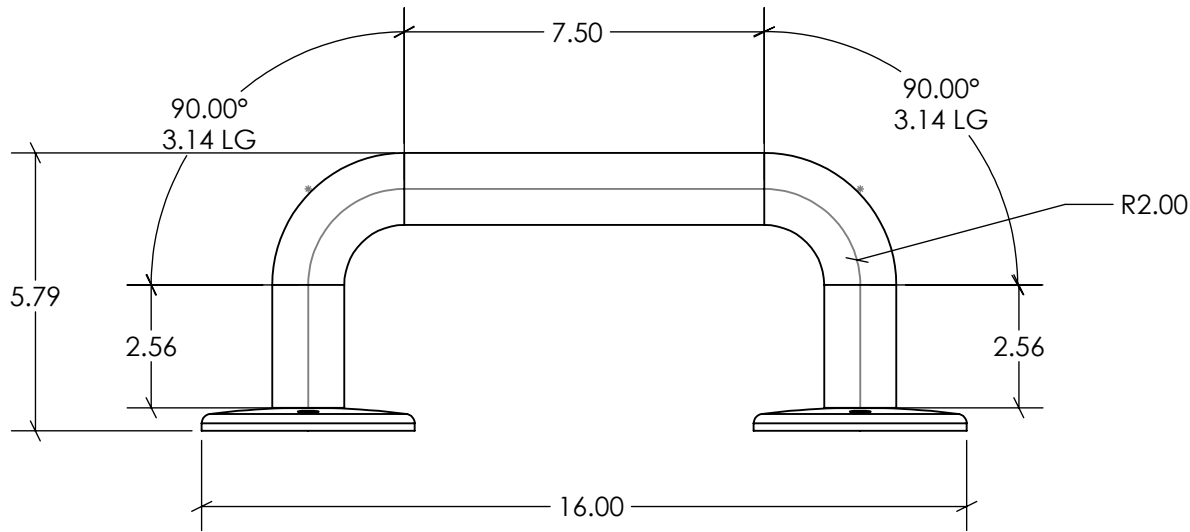

TUBING LENGTH: 18.96"

UNLESS OTHERWISE SPECIFIED
DIMENSIONS ARE IN INCHES,
TOLERANCES ARE:
FRACTIONAL: ±1/16
ANGULAR: ±1°
TWO PLACE DECIMAL: ±.06
THREE PLACE DECIMAL: .. ±.031

DESCRIPTION:

16" BENT ADA TRANSFER RAIL
W/FLANGES

MATERIAL:

1.50" O.D. x .120 WALL (316L)

PART NO.: EB-16A

REV. A

DRAWN BY: DTJ

DATE: 6/23/12

CHECKED BY:

DATE:



P.O. BOX 400 - 1017 S.W. BERG PARKWAY
CANBY, OREGON 97013
PHONE (503) 266-2231